

A valuation problem for strict partitions – and where it comes from

Volker Strehl

Department Informatik
Friedrich-Alexander-Universität
Erlangen-Nürnberg (Germany)

MSU Seminar on Combinatorics and Graph Theory
April 7, 2021

1 What?

- Strict Partitions
- Join-irreducibles
- Shifted tableaux
- Exploration

2 How?

- Some families of symmetric functions
- Schur symmetric functions
- The results
- The tool: divided differences
- 2-part partitions
- Join-irreducibles

3 Why?

- The AEPA model
- The generalized AEPA
- Obtaining the partition function

What?

the sublattice \mathcal{S} of strict partitions

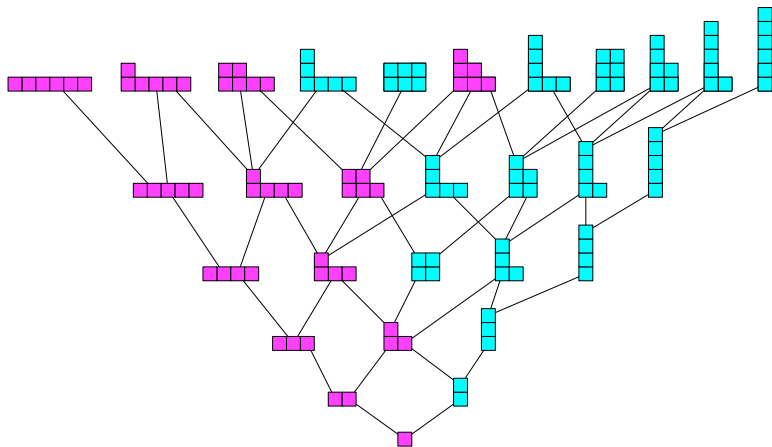

strict partitions

- Strict partitions can be denoted/illustrated as

partitions : (7, 6, 4, 1)

binary sequences : 1101001

decimal integers : 105

diagrams :

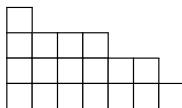

shifted diagrams :

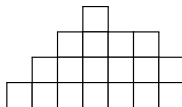

- The covering relation of \mathcal{S} in binary notation
(switching 01 to 10 in position r)

$$b_\ell \dots b_{r+2} \underline{01} b_{r-1} \dots b_2 b_1 \triangleleft_r b_\ell \dots b_{r+2} \underline{10} b_{r-1} \dots b_2 b_1$$

strict partitions

Strict partitions written as partitions

$$\begin{array}{ccccccc}
 (3,2,1) & \xrightarrow{3} & (4,2,1) & \xrightarrow{2} & (4,3,1) & \xrightarrow{1} & (4,3,2) \xrightarrow{0} (4,3,2,1) \\
 \uparrow_0 & & \uparrow_0 & & \uparrow_0 & & \\
 (3,2) & \xrightarrow{3} & (4,2) & \xrightarrow{2} & (4,3) & & \\
 \uparrow_1 & & \uparrow_1 & & & & \\
 (2,1) & \xrightarrow{2} & (3,1) & \xrightarrow{3} & (4,1) & & \\
 \uparrow_0 & & \uparrow_0 & & \uparrow_0 & & \\
 \emptyset & \xrightarrow{0} & (1) & \xrightarrow{1} & (2) & \xrightarrow{2} & (3) \xrightarrow{3} (4)
 \end{array}$$

dominance order ($n = 4$)

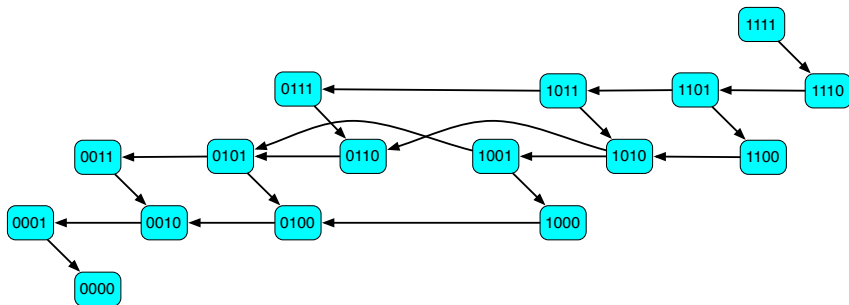

join-irreducible strict partitions

- The *join-irreducible* strict partitions are precisely the partitions

$$\lambda = (n, n-1, \dots, n-k+1, n-k)$$

$$\leftrightarrow 00 \dots 0 \underbrace{11 \dots 1}_{k+1} \underbrace{00 \dots 0}_{n-k-1}$$

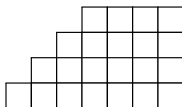

$\langle 7, 3 \rangle$

- Writing $\langle n, k \rangle$ for the partition λ , the poset of join-irreducibles displays as

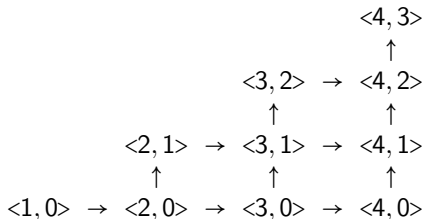

join-irreducible strict partitions

- Join-irreducibles are the “backbone” of the (distributive) lattice of strict partitions
- Strict partitions are (bijectively) joins over antichains (or lower ideals) of the poset of join-irreducibles

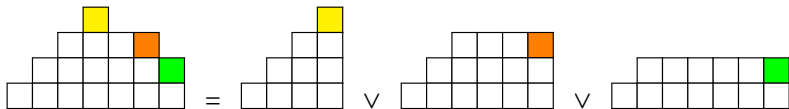

join-irreducible strict partitions

Join-irreducibles in the lattice of strict partitions

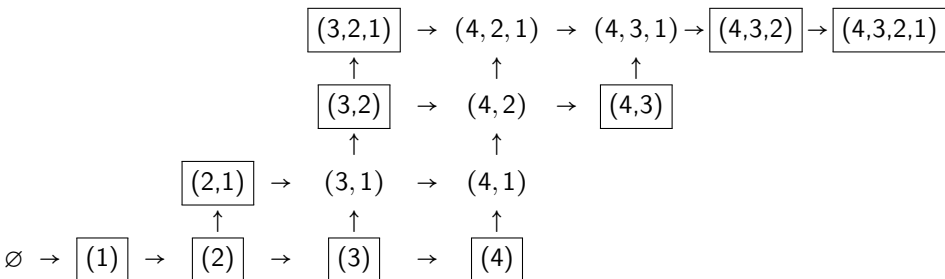

join-irreducible strict partitions

Poset of join-irreducibles

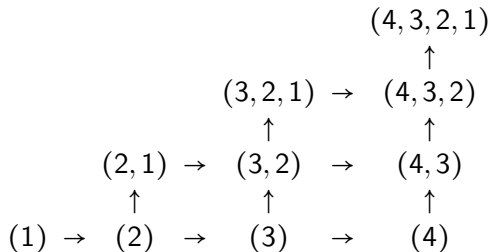

shifted tableaux

- A *shifted standard (Young) tableau* (sSYT) for a shifted diagram of a strict partition λ of size n is
 - a filling of the n boxes with $1, 2, \dots, n$ (bijectively) that is strictly increasing along rows and columns, e.g.,

				12		
			7	11		
		3	5	10	13	
1	2	4	6	8	9	

shifted tableaux

- For $\lambda = (4, 2)$ the set of *sSYT*s of shape λ consists of



- Such a *sSYT* t is nothing but a covering sequence of strict partitions

$$t : \emptyset \triangleleft \lambda^{(1)} \triangleleft \lambda^{(2)} \triangleleft \lambda^{(3)} \triangleleft \dots \triangleleft \lambda^{(s)} \triangleleft \lambda^{(s+1)} \triangleleft \dots \triangleleft \lambda^{|\lambda|} = \lambda$$



weighted shifted tableaux

- $X = \{x_0, x_1, x_2, \dots\}$: set of variables, $X_{a,b} = \{x_a, x_{a+1}, \dots, x_{b-1}, x_b\}$
- The *weight* of a strict partition $\lambda = (\lambda_1, \lambda_2, \dots, \lambda_k)$ is

$$w(\lambda) = x_{\lambda_1} + x_{\lambda_2} + \dots + x_{\lambda_k} (+x_0).$$

x_0 is taken or not so as to make the total number of summands even

- The *total weight of a tableau* t of (shifted) shape λ is then

$$w(t) = \prod_{1 \leq s \leq |\lambda|} w(\lambda^{(s)})$$

- As an abbreviation

$$X_{abc\dots} = X_{a,b,c,\dots} = X_a + X_b + X_c \dots$$

weighted shifted tableaux

- A shifted tableau t for $\lambda = (4, 2, 1)$

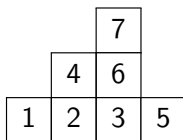

- as a weighted sequence of strict partitions

i	1	2	3	4	5	6	7
$\lambda^{(i)}$	(1)	(2)	(3)	(3, 1)	(4, 1)	(4, 2)	(4, 2, 1)
$w(\lambda^{(i)})$	$x_0 + x_1$	$x_0 + x_2$	$x_0 + x_3$	$x_1 + x_3$	$x_1 + x_4$	$x_2 + x_4$	$x_0 + x_1 + x_2 + x_4$

- and with total weight

$$\begin{aligned}
 w(t) &= (x_0 + x_1)(x_0 + x_2)(x_0 + x_3)(x_1 + x_3)(x_1 + x_4)(x_2 + x_4)(x_0 + x_1 + x_2 + x_4) \\
 &= x_{01}x_{02}x_{03}x_{13}x_{14}x_{24}x_{0124}
 \end{aligned}$$

the problem

- Problem: For the strict partitions $\lambda \in \mathcal{S}$ compute

$$Y_\lambda = \sum \left\{ \frac{1}{w(t)} ; t \in sSYT(\lambda) \right\}$$

- Equivalently: Solve the linear system

$$w(\lambda) \cdot Y_\lambda = \sum \{ Y_\mu ; \mu \triangleleft \lambda \} \quad (\lambda \in \mathcal{S}), \quad Y_\emptyset = 1$$

where \triangleleft is the covering relation in the lattice of strict partitions

- The Y_λ are rational functions in the x_0, x_1, x_2, \dots
- What about a solution in “closed form” ?

the linear system

$$\begin{array}{rcl}
 x_{01} \cdot Y_{(1)} & = & Y_{\emptyset} \\
 x_{02} \cdot Y_{(2)} & = & Y_{(1)} \\
 x_{12} \cdot Y_{(2,1)} & = & Y_{(2)} \\
 x_{03} \cdot Y_{(3)} & = & Y_{(2)} \\
 x_{13} \cdot Y_{(3,1)} & = & Y_{(2,1)} + Y_{(3)} \\
 x_{23} \cdot Y_{(3,2)} & = & Y_{(3,1)} \\
 x_{0123} \cdot Y_{(3,2,1)} & = & Y_{(3,2)} \\
 x_{04} \cdot Y_{(4)} & = & Y_{(3)} \\
 x_{14} \cdot Y_{(4,1)} & = & Y_{(3,1)} + Y_{(4)} \\
 x_{24} \cdot Y_{(4,2)} & = & Y_{(3,2)} + Y_{(4,1)} \\
 x_{0124} \cdot Y_{(4,2,1)} & = & Y_{(3,2,1)} + Y_{(4,2)} \\
 \vdots & = & \vdots
 \end{array}$$

first values

$$Y_{(1)} \rightarrow \frac{1}{x_0 + x_1}$$

$$Y_{(2)} \rightarrow \frac{1}{(x_0 + x_1)(x_0 + x_2)}$$

$$Y_{(2,1)} \rightarrow \frac{1}{(x_1 + x_2)(x_0 + x_1)(x_0 + x_2)}$$

$$Y_{(3)} \rightarrow \frac{1}{(x_0 + x_1)(x_0 + x_2)(x_0 + x_3)}$$

$$Y_{(3,1)} \rightarrow \frac{x_0 + x_1 + x_2 + x_3}{(x_0 + x_1)(x_0 + x_2)(x_0 + x_3)(x_1 + x_2)(x_1 + x_3)}$$

$$Y_{(3,2)} \rightarrow \frac{x_0 + x_1 + x_2 + x_3}{(x_0 + x_1)(x_0 + x_2)(x_0 + x_3)(x_1 + x_2)(x_1 + x_3)(x_2 + x_3)}$$

$$Y_{(3,2,1)} \rightarrow \frac{1}{(x_0 + x_1)(x_0 + x_2)(x_0 + x_3)(x_1 + x_2)(x_1 + x_3)(x_2 + x_3)}$$

- $Y_{(4,2,1)}$:

$$\frac{x_3^2 + x_2x_3 + x_4x_3 + x_4^2 + x_2x_4 + x_1(x_2 + x_3 + x_4) + x_0(x_1 + x_2 + x_3 + x_4)}{\prod \{x_i + x_j; 0 \leq i < j \leq 4; i < 3\}}$$

- $Y_{(4,3)}$:

$$\frac{1}{\prod \{x_i + x_j; 0 \leq i < j \leq 4\}} \left((x_1 + x_2 + x_3 + x_4)x_0^2 + (x_1 + x_2 + x_3 + x_4)^2x_0 + x_1(x_2 + x_3 + x_4)^2 + (x_2 + x_3)(x_2 + x_4)(x_3 + x_4) + x_1^2(x_2 + x_3 + x_4) \right)$$

- $Y_{(4,3,1)}$ defined:

$$Y_{(4,3,1)} = \frac{1}{x_0 + x_1 + x_3 + x_4} (Y_{(4,2,1)} + Y_{(4,3)})$$

- $Y_{(4,3,1)}$ computed:

$$\frac{(x_0 + x_2 + x_3 + x_4)(x_1 + x_2 + x_3 + x_4)}{\prod \{x_i + x_j; 0 \leq i < j \leq 4\}}$$

- $Y_{(4,3,2)}$ defined:

$$Y_{(4,3,2)} = \frac{1}{x_0 + x_2 + x_3 + x_4} Y_{(4,3,1)}$$

- $Y_{(4,3,2)}$ computed:

$$Y_{(4,3,2)} = \frac{x_1 + x_2 + x_3 + x_4}{\prod \{x_i + x_j; 0 \leq i < j \leq 4\}}$$

- $Y_{(4,3,2,1)}$ defined:

$$Y_{(4,3,2,1)} = \frac{1}{x_1 + x_2 + x_3 + x_4} Y_{(4,3,2)}$$

- $Y_{(4,3,2,1)}$ computed:

$$Y_{(4,3,2,1)} = \frac{1}{\prod \{x_i + x_j; 0 \leq i < j \leq 4\}}$$

numerator of $Y_{(5,2)}$

$$\begin{aligned}
& \left(x_1^2 + (x_2 + x_3 + x_4 + x_5) x_1 + x_2^2 + x_3 x_4 + x_3 x_5 + x_4 x_5 + x_2 (x_3 + x_4 + x_5) \right) x_0^3 \\
& + \left(x_1^3 + 2(x_2 + x_3 + x_4 + x_5) x_1^2 + (2x_2^2 + 3(x_3 + x_4 + x_5) x_2 + x_3^2 + x_4^2 + x_5^2 + 3x_4 x_5 + 3x_3(x_4 + x_5)) x_1 \right. \\
& \quad \left. + x_2^3 + x_3 x_4^2 + x_3 x_5^2 + x_4 x_5^2 + x_3^2 x_4 + x_3^2 x_5 + x_4^2 x_5 + 3x_3 x_4 x_5 + 2x_2^2 (x_3 + x_4 + x_5) \right. \\
& \quad \left. + x_2 (x_3^2 + 3(x_4 + x_5) x_3 + x_4^2 + x_5^2 + 3x_4 x_5) \right) x_0^2 \\
& + \left((x_2 + x_3 + x_4 + x_5) x_1^3 + (2x_2^2 + 3(x_3 + x_4 + x_5) x_2 + x_3^2 + x_4^2 + x_5^2 + 3x_4 x_5 + 3x_3(x_4 + x_5)) x_1^2 \right. \\
& \quad \left. + (x_2^3 + 3(x_3 + x_4 + x_5) x_2^2 + (2x_3^2 + 5(x_4 + x_5) x_3 + 2x_4^2 + 2x_5^2 + 5x_4 x_5) x_2 + 2x_3^2 (x_4 + x_5) + 2x_4 x_5 (x_4 + x_5) \right. \\
& \quad \left. + x_3 (2x_4^2 + 5x_5 x_4 + 2x_5^2)) x_1 + (x_4 x_5 + x_3 (x_4 + x_5))^2 + x_2^3 (x_3 + x_4 + x_5) \right) x_0 \\
& + x_2^2 \left(x_3^2 + 3(x_4 + x_5) x_3 + x_4^2 + x_5^2 + 3x_4 x_5 \right) + x_2 \left(2(x_4 + x_5) x_3^2 + (2x_4^2 + 5x_5 x_4 + 2x_5^2) x_3 + 2x_4 x_5 (x_4 + x_5) \right) \\
& \quad + (x_2 + x_3) (x_2 + x_4) (x_2 + x_5) (x_4 x_5 + x_3 (x_4 + x_5)) + x_1^3 \left(x_2^2 + (x_3 + x_4 + x_5) x_2 + x_4 x_5 + x_3 (x_4 + x_5) \right) \\
& + x_1^2 \left(x_2^3 + 2(x_3 + x_4 + x_5) x_2^2 + (x_3^2 + 3(x_4 + x_5) x_3 + x_4^2 + x_5^2 + 3x_4 x_5) x_2 + x_3^2 (x_4 + x_5) + x_4 x_5 (x_4 + x_5) \right. \\
& \quad \left. + x_3 (x_4^2 + 3x_5 x_4 + x_5^2) \right) + x_1 \left((x_3 + x_4 + x_5) x_3^2 + (x_3^2 + 3(x_4 + x_5) x_3 + x_4^2 + x_5^2 + 3x_4 x_5) x_2^2 + (2(x_4 + x_5) x_3^2 \right. \\
& \quad \left. + (2x_4^2 + 5x_5 x_4 + 2x_5^2) x_3 + 2x_4 x_5 (x_4 + x_5)) x_2 + (x_4 x_5 + x_3 (x_4 + x_5))^2 \right)
\end{aligned}$$

denominator of $Y_{(5,2)}$

$$(x_0 + x_1) (x_0 + x_2) (x_1 + x_2) (x_0 + x_3) (x_1 + x_3) (x_2 + x_3) (x_0 + x_4) (x_1 + x_4) (x_2 + x_4) (x_0 + x_5) (x_1 + x_5) (x_2 + x_5)$$

about denominators

- For $n > k \geq 0$ define *standard denominator polynomials*

$$q_{n,k}(x_0, x_1, x_2, \dots, x_n) = \prod_{0 \leq i \leq k} \prod_{i < j \leq n} (x_i + x_j) = \prod_{(j,i) \leq (n,k)} (x_i + x_j)$$

- The polynomials $q_{n,k}$ are in 1-1-correspondence with the join irreducibles in the lattice \mathcal{S}
- $q_{n,k}(x_0, x_1, x_2, \dots, x_n)$ is a polynomial that is separately symmetric in $X_{0,k} = \{x_0, x_1, \dots, x_k\}$ and in $X_{k+1,n} = \{x_{k+1}, x_{k+2}, \dots, x_n\}$.
- The case $k = n - 1$ is special, however, because $q_{n,n-1}$ is symmetric in all variables $X_{0,n} = \{x_0, x_1, \dots, x_n\}$.
- The degree of $q_{n,k}$ is

$$\sum_{i=0}^k (n-i) = (k+1)n - \binom{k+1}{2} = \frac{(k+1)(2n-k)}{2}.$$

about denominators

- From the computed data one is led to conjecture
 - For all $\lambda \in \mathcal{S}$ with $\lambda = (n, k, \dots)$

$$Y_\lambda = \frac{p_\lambda}{q_{n,k}},$$

where p_λ is a polynomial, $q_{n,k}$ is the standard denominator polynomial, i.e., the denominator of Y_λ

- depends only on the two largest parts of λ
 - is a product of binomials
- This is indeed true!

a special case: partitions $(n, 1)$

- Task: compute the rational functions Y_λ for the very special case of 2-part partitions of type $\lambda = (n, 1)$ for all $n \geq 2$.
- One-part partitions are easy: because of

$$Y_{(n)} = \frac{1}{x_0 + x_n} Y_{(n-1)} \quad \text{for } n > 0$$

we have

$$Y_{(n)} = \frac{1}{\prod_{1 \leq i \leq n} (x_0 + x_i)} = \frac{1}{q_{n,0}}.$$

- The computation of $Y_{(n,1)}$ in general is not so obvious. One gets as first values (writing $x_{abc\dots}$ for $x_a + x_b + x_c + \dots$)

$$Y_{(2,1)} = \frac{1}{x_{12}} Y_{(2)} = \frac{1}{x_{01}x_{02}x_{12}} = \frac{1}{q_{2,1}}$$

$$Y_{(3,1)} = \frac{1}{x_{13}} (Y_{(2,1)} + Y_{(3)}) = \frac{x_{0123}}{x_{01}x_{02}x_{03}x_{12}x_{13}} = \frac{x_{03} + x_{12}}{q_{3,1}}$$

a special case: partitions $(n, 1)$

$$Y_{(4,1)} = \frac{1}{x_{14}} (Y_{(3,1)} + Y_{(4)}) = \dots = \frac{x_{03}x_{04} + x_{12}x_{04} + x_{12}x_{13}}{q_{4,1}}$$

$$\begin{aligned} Y_{(5,1)} &= \frac{1}{x_{15}} (Y_{(4,1)} + Y_{(5)}) \\ &= \dots = \frac{x_{05}x_{04}x_{03} + x_{05}x_{04}x_{12} + x_{05}x_{13}x_{12} + x_{14}x_{13}x_{12}}{q_{5,1}} \end{aligned}$$

- Examples suggests that in general

$$Y_{(n,1)} = \frac{\sum_{\lambda} \prod_{i=1}^{n-2} (x_{\lambda_i} + x_{\lambda'_i})}{q_{n,1}}$$

where \sum_{λ} runs over all $\lambda \in \mathcal{S}$ with

$$\underline{\tau}^{(n)} = (n-1, n-2, \dots, 3, 2) \leq \lambda \leq \overline{\tau}^{(n)} = (n, n-1, \dots, 4, 3)$$

$$\lambda' = \overline{\tau}^{(n)} - \lambda$$

λ' is not a strict partition, but a vector of type $0^{\ell}1^{n-2-\ell}$.

a special case: partitions $(n, 1)$

- To illustrate this in the case $n = 5$:
 - The relevant λ with $\underline{\tau}^{(5)} = 432 \leq \lambda \leq \overline{\tau}^{(5)} = 543$ are

λ'	000	001	011	111
λ	543	542	532	432

- Compare with

$$Y_{(5,1)} = \frac{x_{05}x_{04}x_{03} + x_{05}x_{04}x_{12} + x_{05}x_{13}x_{12} + x_{14}x_{13}x_{12}}{q_{5,1}}$$

a special case: partitions $(n, 1)$

This is routinely verified by induction:

$$\begin{aligned}
 Y_{(n+1,1)} &= \frac{1}{x_1 + x_{n+1}} (Y_{(n,1)} + Y_{(n+1)}) \\
 &= \frac{1}{x_1 + x_{n+1}} \left(\frac{\sum_{\lambda} \prod_{i=1}^{n-2} (x_{\lambda_i} + x_{\lambda'_i})}{q_{n,1}} + \frac{1}{q_{n+1,0}} \right) \\
 &= \frac{1}{q_{n+1,1}} \frac{1}{(x_1 + x_{n+1})} \times \\
 &\quad \times \left(\sum_{\lambda} \prod_{i=1}^{n-2} (x_{\lambda_i} + x_{\lambda'_i}) \cdot (x_0 + x_{n+1})(x_1 + x_{n+1}) + \prod_{1 < j \leq n+1} (x_1 + x_j) \right) \\
 &= \frac{1}{q_{n+1,1}} \left(\underbrace{\sum_{\lambda} \prod_{i=1}^{n-2} (x_{\lambda_i} + x_{\lambda'_i}) \cdot (x_0 + x_{n+1})}_{\mu=(n+1,\lambda)} + \underbrace{\prod_{1 < j \leq n} (x_1 + x_j)}_{\mu=(n,n-1,\dots,3,2)} \right)
 \end{aligned}$$

a special case: partitions $(n, 1)$

- One can rewrite the formula for $Y_{(n,1)}$ in a much neater way in terms of symmetric functions. Indeed,

$$Y_{(n,1)} = \frac{1}{q_{n,1}} \sum_{k=0}^{n-2} h_k(X_{0,1}) \cdot e_{n-2-k}(X_{2,n}),$$

where the $h_k(A)$ resp. $e_\ell(B)$ denote the homogeneous resp. elementary symmetric functions over the alphabets A resp. B .

- Once one has made this guess, it is a routine matter to verify that indeed both sides of

$$\sum_{\lambda} \prod_{i=1}^{n-2} (x_{\lambda_i} + x_{\lambda'_i}) = \sum_{k=0}^{n-2} h_k(X_{0,1}) \cdot e_{n-2-k}(X_{2,n})$$

contain the same monomials.

a special case: partitions $(n, 1)$

As an illustration for $n = 4$:

$$\begin{aligned}
 h_2(X_{0,1})e_0(X_{2,4}) + h_1(X_{0,1})e_1(X_{2,4}) + h_0(X_{0,1})e_2(X_{2,4}) \\
 &= \dots \\
 &= x_1^2 + (x_0 + x_1 + x_2 + x_3)(x_0 + x_4) + x_1(x_2 + x_3) + x_2x_3 \\
 &= (x_0 + x_3)(x_0 + x_4) + (x_2 + x_3)(x_0 + x_4) + (x_1 + x_2)(x_2 + x_3)
 \end{aligned}$$

a special case: partitions $(n, 1)$

- This identifies the numerator of $Y_{(n,1)}$ as a Schur polynomial over a pair alphabets, viz.

$$\sum_{k=0}^{n-2} h_k(X_{0,1}) \cdot e_{n-2-k}(X_{2,n}) = S_{n-2}(X_{0,1}|X_{2,n}).$$

- This view is interesting because the denominator polynomials $q_{n,1}$, and the $q_{n,k}$ in general, can be written as Schur polynomials over a pair of alphabets:

$$q_{n,k} = S_{\langle n,k \rangle}(X_{0,k}|X_{k+1,n}),$$

where $\langle n, k \rangle = (n, n-1, \dots, n-k)$ is the corresponding join-irreducible strict partition

How?

elementary and homogeneous symmetric functions

- $A = \{a, b, c, \dots\}$ a finite alphabet (commuting variables)
mostly $A = X_{\ell, m} = \{x_\ell, x_{\ell+1}, \dots, x_m\}$ for some $0 \leq \ell \leq m$
- *elementary symmetric functions* $e_k(a)$ by gf

$$\sum_{k \geq 0} e_k(A) t^k = \prod_{\alpha \in A} (1 + \alpha t)$$

- *homogenous (complete) symmetric functions* $h_k(A)$ by gf

$$\sum_{k \geq 0} h_k(A) t^k = \prod_{\alpha \in A} \frac{1}{1 - \alpha t}$$

Schur functions (1)

- *Schur symmetric functions*

- For $A = \{x_1, x_2, \dots, x_a\}$ and a partition $\lambda = (\lambda_1, \dots, \lambda_n)$ with $n \leq a$

$$s_\lambda(A) = \frac{\det \left| x_i^{\lambda_j + a - j} \right|_{1 \leq i, j \leq a}}{\det \left| x_i^{a - j} \right|_{1 \leq i, j \leq a}}$$

- Equivalently (Jacobi-Trudi determinant)

$$s_\lambda(A) = \det \begin{bmatrix} h_{\lambda_n} & h_{\lambda_{n-1}+1} & \cdots & h_{\lambda_1+n-1} \\ h_{\lambda_{n-1}} & h_{\lambda_{n-1}} & \cdots & h_{\lambda_1+n-2} \\ \vdots & \vdots & \ddots & \vdots \\ h_{\lambda_{n-n+1}} & h_{\lambda_{n-1}-n+2} & \cdots & h_{\lambda_1} \end{bmatrix}_A$$

- In particular

$$h_k(A) = s_{(k)}(A) \quad e_k(A) = s_{(1^k)}(A)$$

Schur functions (3)

- Jacobi-Trudi identities by example

$$\begin{aligned}
 s_{4,2,1} &= \det \begin{vmatrix} h_1 & h_3 & h_6 \\ h_0 & h_2 & h_5 \\ 0 & h_1 & h_4 \end{vmatrix} \\
 &= h_1 h_2 h_4 - h_3 h_4 - h_1^2 h_5 + h_1 h_6 \\
 &= \det \begin{vmatrix} e_1 & e_2 & e_4 & e_6 \\ e_0 & e_1 & e_3 & e_5 \\ 0 & e_0 & e_2 & e_4 \\ 0 & 0 & e_1 & e_3 \end{vmatrix} \\
 &= e_1^2 e_2 e_3 - e_2^2 e_3 - e_1 e_3^2 - e_1^3 e_4 + e_1 e_2 e_4 + e_3 e_4
 \end{aligned}$$

Schur functions (5)

- The Schur function $s_{4,2,1}(\{x_1, \dots, x_4\})$ fully expanded

$$\begin{aligned}
 & x_1^4 x_2^2 x_3 + x_1^3 x_2^3 x_3 + x_1^2 x_2^4 x_3 + x_1^4 x_2 x_3^2 + 2x_1^3 x_2^2 x_3^2 + 2x_1^2 x_2^3 x_3^2 + x_1 x_2^4 x_3^2 \\
 & + x_1^3 x_2 x_3^3 + 2x_1^2 x_2^2 x_3^3 + x_1 x_2^3 x_3^3 + x_1^2 x_2 x_3^4 + x_1 x_2^2 x_3^4 + x_1^4 x_2^2 x_4 + x_1^3 x_2^3 x_4 + x_1^2 x_2^4 x_4 \\
 & + 2x_1^4 x_2 x_3 x_4 + 4x_1^3 x_2^2 x_3 x_4 + 4x_1^2 x_2^3 x_3 x_4 + 2x_1 x_2^4 x_3 x_4 + x_1^4 x_3^2 x_4 + 4x_1^3 x_2 x_3^2 x_4 \\
 & + 6x_1^2 x_2^2 x_3^2 x_4 + 4x_1 x_2^3 x_3^2 x_4 + x_2^4 x_3^2 x_4 + x_1^3 x_3^3 x_4 + 4x_1^2 x_2 x_3^3 x_4 + 4x_1 x_2^2 x_3^3 x_4 + x_2^3 x_3^3 x_4 \\
 & + x_1^2 x_3^4 x_4 + 2x_1 x_2 x_3^4 x_4 + x_2^2 x_3^4 x_4 + x_1^4 x_2 x_4^2 + 2x_1^3 x_2^2 x_4^2 + 2x_1^2 x_2^3 x_4^2 + x_1 x_2^4 x_4^2 \\
 & + x_1^4 x_3 x_4^2 + 4x_1^3 x_2 x_3 x_4^2 + 6x_1^2 x_2^2 x_3 x_4^2 + 4x_1 x_2^3 x_3 x_4^2 + x_2^4 x_3 x_4^2 + 2x_1^3 x_3^2 x_4^2 + 6x_1^2 x_2 x_3^2 x_4^2 \\
 & + 6x_1 x_2^2 x_3^2 x_4^2 + 2x_2^3 x_3^2 x_4^2 + 2x_1^2 x_3^3 x_4^2 + 4x_1 x_2 x_3^3 x_4^2 + 2x_2^2 x_3^3 x_4^2 + x_1 x_3^4 x_4^2 + x_2 x_3^4 x_4^2 \\
 & + x_1^3 x_2 x_4^3 + 2x_1^2 x_2^2 x_4^3 + x_1 x_2^3 x_4^3 + x_1^3 x_3 x_4^3 + 4x_1^2 x_2 x_3 x_4^3 + 4x_1 x_2^2 x_3 x_4^3 + x_2^3 x_3 x_4^3 \\
 & + 2x_1^2 x_3^2 x_4^3 + 4x_1 x_2 x_3^2 x_4^3 + 2x_2^2 x_3^2 x_4^3 + x_1 x_3^3 x_4^3 + x_2 x_3^3 x_4^3 + x_1^2 x_2 x_4^4 + x_1 x_2^2 x_4^4 \\
 & + x_1^2 x_3 x_4^4 + 2x_1 x_2 x_3 x_4^4 + x_2^2 x_3 x_4^4 + x_1 x_3^2 x_4^4 + x_2 x_3^2 x_4^4
 \end{aligned}$$

Schur functions (6)

- $\Delta_a = \langle a, a-1 \rangle = (a, a-1, a-2, \dots, 2, 1)$: staircase of size $\binom{a+1}{2}$

(1) If $X_{\ell,m} = \{x_\ell, x_{\ell+1}, \dots, x_m\}$ is an alphabet of size a , then

$$s_{\Delta_a}(X_{\ell,m}) = \prod_{\ell \leq i \leq m} x_i \cdot \prod_{\ell \leq j < k \leq m} (x_j + x_k)$$

(2) If $X_{\ell,m}$ is an alphabet of size $a+1$, then

$$s_{\Delta_a}(X_{\ell,m}) = \prod_{\ell \leq j < k \leq m} (x_j + x_k)$$

- If $\#A > a+1$ then $s_{\Delta_a}(A)$ does not factor (let alone factor into linear factors)
- Obviously $s_{\Delta_a}(A) = 0$ if $\#A < a$.

Schur functions (7)

- Schur functions over a pair $(A|B)$ of alphabets
 - Definition of $S_n(A|B)$ for $n \in \mathbb{N}$

$$\sum_{n \geq 0} S_n(A|B) t^n = \frac{\prod_{\beta \in B} (1 + \beta t)}{\prod_{\alpha \in A} (1 - \alpha t)}$$

$$S_n(A|B) = \sum_{k=0}^n h_k(A) \cdot e_{n-k}(B)$$

- Definition of $S_\lambda(A|B)$ for partitions $\lambda = (\lambda_1, \dots, \lambda_n)$ via an JT determinant

$$S_\lambda(A|B) = \det \begin{vmatrix} S_{\lambda_n} & S_{\lambda_{n-1}+1} & \cdots & S_{\lambda_1+n-1} \\ S_{\lambda_{n-1}} & S_{\lambda_{n-1}} & \cdots & S_{\lambda_1+n-2} \\ \vdots & \vdots & \ddots & \vdots \\ S_{\lambda_{n-n+1}} & S_{\lambda_{n-1}-n+2} & \cdots & S_{\lambda_1} \end{vmatrix} (A|B)$$

- Alternatively: $S_\lambda(A|B) = \sum_{\mu \subseteq \lambda} S_\mu(A) S_{\lambda \setminus \mu}(B)$

Schur functions (8)

- The Schur function $S_{4,2,1}(\{x_1, x_2\}|\{x_3, x_4\})$ fully expanded:

$$\begin{aligned}
 & x_1^4 x_2^2 x_3 + x_1^3 x_2^3 x_3 + x_1^2 x_2^4 x_3 + x_1^4 x_2 x_3^2 + 2x_1^3 x_2^2 x_3^2 + 2x_1^2 x_2^3 x_3^2 + x_1 x_2^4 x_3^2 \\
 & + x_1^3 x_2 x_3^3 + x_1^2 x_2^2 x_3^3 + x_1 x_2^3 x_3^3 + x_1^4 x_2^2 x_4 + x_1^3 x_2^3 x_4 + x_1^2 x_2^4 x_4 + 2x_1^4 x_2 x_3 x_4 \\
 & + 4x_1^3 x_2^2 x_3 x_4 + 4x_1^2 x_2^3 x_3 x_4 + 2x_1 x_2^4 x_3 x_4 + x_1^4 x_3^2 x_4 + 4x_1^3 x_2 x_3^2 x_4 + 5x_1^2 x_2^2 x_3^2 x_4 \\
 & + 4x_1 x_2^3 x_3^2 x_4 + x_2^4 x_3^2 x_4 + x_1^3 x_3^3 x_4 + 2x_1^2 x_2 x_3^3 x_4 + 2x_1 x_2^2 x_3^3 x_4 + x_2^3 x_3^3 x_4 \\
 & + x_1^4 x_2 x_4^2 + 2x_1^3 x_2^2 x_4^2 + 2x_1^2 x_2^3 x_4^2 + x_1 x_2^4 x_4^2 + x_1^4 x_3 x_4^2 + 4x_1^3 x_2 x_3 x_4^2 + 5x_1^2 x_2^2 x_3 x_4^2 \\
 & + 4x_1 x_2^3 x_3 x_4^2 + x_2^4 x_3 x_4^2 + 2x_1^3 x_3^2 x_4^2 + 4x_1^2 x_2 x_3^2 x_4^2 + 4x_1 x_2^2 x_3^2 x_4^2 + 2x_2^3 x_3^2 x_4^2 \\
 & + x_1^2 x_3^3 x_4^2 + x_1 x_2 x_3^3 x_4^2 + x_2^2 x_3^3 x_4^2 + x_1^3 x_2 x_4^3 + x_1^2 x_2^2 x_4^3 + x_1 x_2^3 x_4^3 + x_1^3 x_3 x_4^3 \\
 & + 2x_1^2 x_2 x_3 x_4^3 + 2x_1 x_2^2 x_3 x_4^3 + x_2^3 x_3 x_4^3 + x_1^2 x_3^2 x_4^3 + x_1 x_2 x_3^2 x_4^3 + x_2^2 x_3^2 x_4^3
 \end{aligned}$$

main results (1): denominators

- For arbitrary strict partitions $\lambda = (n, k, \dots)$ the denominator of Y_λ depends only on λ_1 and λ_2 and is

$$q_{n,k} = \prod_{\substack{0 \leq i < j \leq n \\ i \leq k}} (x_i + x_j) = S_{\langle n, k \rangle}(X_{0,k} | X_{k+1, n})$$

- The *lcm* of the denominators of the Y_λ with $\max \lambda \leq n$

$$Y_\emptyset = 1, Y_{(1)} = \frac{1}{x_0 + x_1}, \dots, Y_{(n, n-1, \dots, 1)} = \frac{1}{\prod_{0 \leq i < j \leq n} (x_i + x_j)}$$

is

$$s_{\Delta_n}(X_{0,n}) = \prod_{0 \leq i < j \leq n} (x_i + x_j)$$

main results (2): join-irreducibles

- For join-irreducible strict partitions

$$\lambda = \langle n, k \rangle = (n, n-1, \dots, n-k+1, n-k)$$

$$Y_\lambda = \frac{S_{\Delta_{n-k-1}}(X_{k+1 \bmod 2, n})}{S_{\Delta_n}(X_{0, n})}$$

main results (3): two-part partitions

- For two-part strict partitions $\lambda = (n, m)$ with $n > m \geq 1$:

$$Y_{(n,m)} = \frac{S_{\langle n-2, m-1 \rangle}(X_{0,m} | X_{m+1,n})}{S_{\langle n, m \rangle}(X_{0,m} | X_{m+1,n})}$$

where

$$S_{\langle n, m \rangle}(X_{0,m} | X_{m+1,n}) = q_{n,m} = \prod_{\substack{0 \leq i < j \leq n \\ i \leq m}} (x_i + x_j)$$

divided differences

- For $f(x_0, x_1, \dots)$ and $r \geq 0$ let

$$f^{(r)}(x_0, x_1, \dots, x_r, x_{r+1}, \dots) = f(x_0, x_1, \dots, x_{r+1}, x_r, \dots)$$

and

$$f \delta_r = \frac{f^{(r)} - f}{x_r - x_{r+1}}$$

- The δ_r are “derivations” with product rule

$$(f \cdot g) \delta_r = f^{(r)} \cdot (g \delta_r) + (f \delta_r) \cdot g$$

and “Coxeter type relations”

$$\delta_r \circ \delta_r = 0$$

$$\delta_r \circ \delta_{r+1} \neq \delta_{r+1} \circ \delta_r$$

$$\delta_r \circ \delta_s = \delta_s \circ \delta_r \quad \text{if } |r - s| \geq 2 \quad \delta_r \circ \delta_{r+1} \circ \delta_r = \delta_{r+1} \circ \delta_r \circ \delta_{r+1}$$

- The δ_r are symmetrizing operators: $f \delta_r$ is symmetric w.r.t. $x_r \leftrightarrow x_{r+1}$, but other symmetries f had involving x_r or x_{r+1} may no longer exist in $f \delta_r$

covering for strict partitions and divided differences

- Covering in the lattice of strict partitions:

$$\lambda \triangleleft_r \mu \iff \begin{cases} r \in \lambda, \\ r+1 \notin \lambda \\ \mu = \lambda|_{r \rightarrow r+1} \end{cases} \begin{cases} \text{increasing } r \text{ to } r+1 \text{ in } \lambda, \\ \text{if possible,} \\ \text{gives } \mu \end{cases}$$

- The key property:

$$\lambda \triangleleft_r \mu \Rightarrow Y_\lambda \delta_r = \begin{cases} Y_\mu & \text{if } r > 0 \text{ or } |\lambda| \text{ odd} \\ 0 & \text{if } r = 0 \text{ and } |\lambda| \text{ even} \end{cases}$$

strict partitions and divided differences

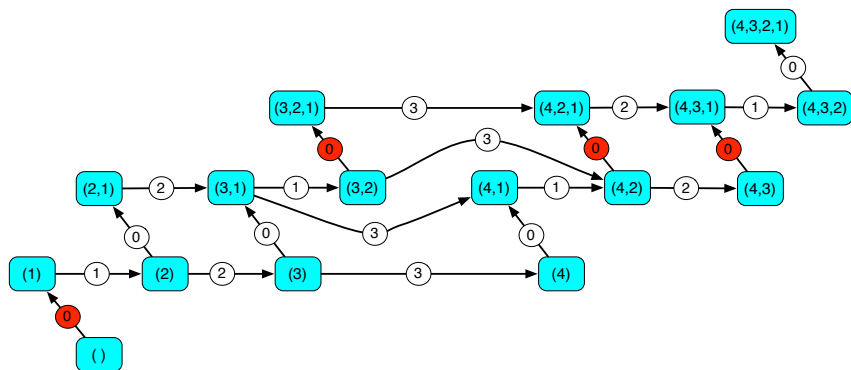

about the 2-part case

- Recall the claim:

$$Y_{(n,m)} = \frac{S_{(n-2,n-3,\dots,n-m-1)}(X_{0,m}|X_{m+1,n})}{\prod_{\substack{0 \leq i < j \leq n \\ i \leq m}} (x_i + x_j)}$$

- Consider partitions $\lambda = (n, m)$ with $n > m \geq 1$ and their extensions $(n+1, m)$ and $(n, m+1)$ (if $m < n-1$):

$$(n, m) \triangleleft_n (n+1, m) \quad (n, m) \triangleleft_m (n, m+1)$$

- Hence

$$Y_{n+1,m} = Y_{n,m} \delta_n \quad Y_{n,m+1} = Y_{n,m} \delta_m$$

about the 2-part case

- Plugging in the asserted results and clearing denominators one gets equivalent polynomial relations (writing from now on $(a..b)$ for $X_{a,b}$)

$$\begin{aligned} [S_{m+1}(n+1|0..m) \cdot S_{n-2,n-3,\dots,n-m-1}(0..m|m+1..n)] \delta_n \\ = S_{n-1,n-2,\dots,n-m}(0..m|m+1..n+1) \end{aligned}$$

and

$$\begin{aligned} [S_{n-m+1}(m+1|m+2..n) \cdot S_{n-2,n-3,\dots,n-m-1}(0..m|m+1..n)] \delta_m \\ = S_{n-2,n-3,\dots,n-m-2}(0..m+1|m+2..n) \end{aligned}$$

join-irreducible strict partitions and divided differences

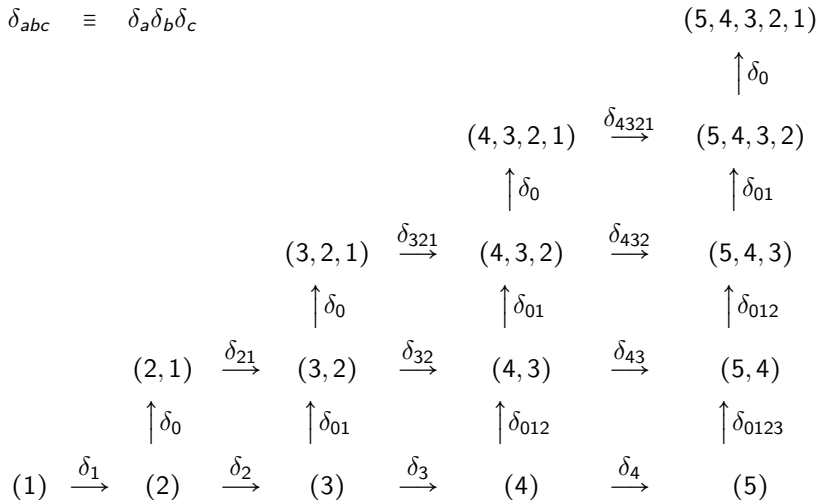

about the join-irreducible case

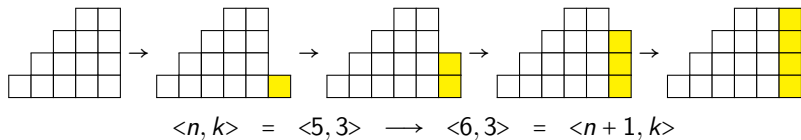

via

$$\begin{aligned}
 \langle n, k \rangle &= (n, n-1, n-2, \dots, n-k) \\
 \langle_n &(n+1, n-1, n-2, \dots, n-k) \\
 \langle_{n-1} &(n+1, n, n-2, \dots, n-k) \\
 &\vdots \\
 \langle_{n-k} &(n+1, n, n-1, \dots, n+1-k) \\
 &= \langle n+1, k \rangle
 \end{aligned}$$

one has

$$Y_{\langle n, k \rangle} \xrightarrow{\delta_{n, n-1, \dots, n-k}} Y_{\langle n+1, k \rangle}$$

about the join-irreducible case

- Plugging in

$$Y_{\langle n, k \rangle} \xrightarrow{\delta_{n, n-1, \dots, n-k}} Y_{\langle n+1, k \rangle}$$

the asserted results and clearing denominators one gets equivalent polynomial relation

$$\left[S_{n+1}(x_{n+1} | X_{0,n}) \cdot S_{\Delta_{n-k-1}}(X_{\varepsilon,n}) \right] \delta_n \delta_{n-1} \dots \delta_{n-k} = S_{\Delta_{n-k}}(X_{\varepsilon,n+1}).$$

- For k even:

$$\prod_{i=0}^{k+n} (x_i + x_{k+n+1}) s_{\Delta_n}(1..k+n) \xrightarrow{\delta_{k+n} \delta_{k+n-1} \dots \delta_{n+1}} s_{\Delta_{n+1}}(1..k+n+1) + x_0 x_1 \dots x_n s_{\Delta_n}(1..k+n+1)$$

- For k odd:

$$\prod_{i=0}^{k+n} (x_i + x_{k+n+1}) s_{\Delta_n}(1..k+n) \xrightarrow{\delta_{k+n} \delta_{k+n-1} \dots \delta_{n+1}} s_{\Delta_{n+1}}(1..k+n+1)$$

Why?

the asymmetric exclusion process with annihilation (Ayyer, Mallick)

- right shift

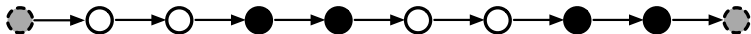
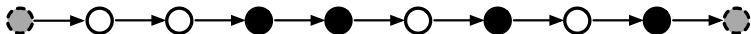

- annihilation

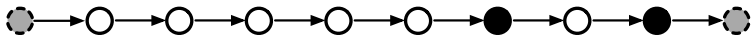
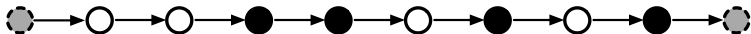

the asymmetric exclusion process with annihilation

- left creation

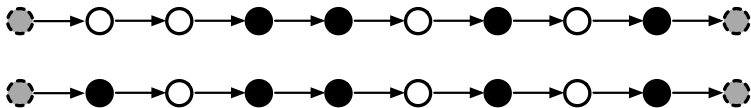

- left annihilation

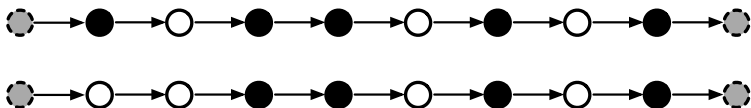

- right annihilation

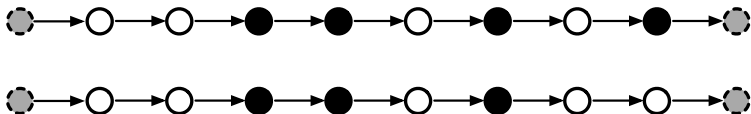

encoding of the process

- Notation
 - \mathbb{B}^n : binary vectors of length n
 - vectors and matrices indexed by \mathbb{B}^n (lexicographically)
- The process
 - states encoded as elements of \mathbb{B}^n
 - transitions "in the bulk" with rate = 1
 - $\dots 10 \dots \mapsto \dots 01 \dots$ (right shift)
 - $\dots 11 \dots \mapsto \dots 00 \dots$ (annihilation)
 - at the left end with rate = α
 - $0 \dots \mapsto 1 \dots$ (left creation)
 - $1 \dots \mapsto 0 \dots$ (left annihilation)
 - at the right end with rate = β
 - $\dots 1 \mapsto \dots 0$ (right annihilation)
- $M_n(\alpha, \beta)$: transition rate matrix of a continuous-time Markov chain

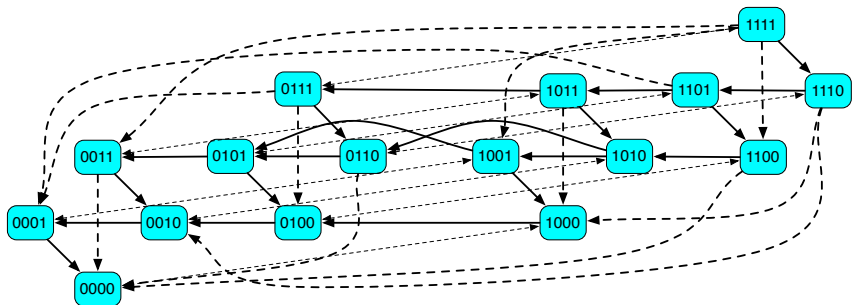
transitions for $n=4$ 

matrix of transition rates for $n = 3$

$$M_3 = \begin{bmatrix} * & \beta & 1 & \alpha & 1 & \\ & * & 1 & & \alpha & 1 \\ & & * & \beta & 1 & \alpha \\ & & & * & 1 & \alpha \\ \alpha & & & * & \beta & 1 \\ & \alpha & & & * & 1 \\ & & \alpha & & & * & \beta \\ & & & \alpha & & & * \end{bmatrix}$$

$\alpha : 0xy \rightarrow 1xy, 1xy \rightarrow 0xy$

$1 : 11y \rightarrow 00y, 10y \rightarrow 01y$

$1 : x11 \rightarrow x00, x10 \rightarrow x01$

$\beta : xy1 \rightarrow xy0$

$*$: column sums = 0

left creation and annihilation

right shift and annihilation

right shift and annihilation

right annihilation

$\langle 1 \dots 1 |$ as left eigenvector

results for $M_n(\alpha, \beta)$

(Ayyer, Mallick)

- The model admits a “transfer matrix Ansatz”:
there are matrices $T_{n+1,n}$ of size $2^{n+1} \times 2^n$ s.th.

$$T_{n+1,n} \cdot M_n(\alpha, \beta) = M_{n+1}(\alpha, \beta) \cdot T_{n+1,n}$$

- Nontrivial right kernel vectors v_n of M_n can be computed inductively:

$$M_n |v_n\rangle = 0 \quad \Rightarrow \quad M_{n+1} \underbrace{T_{n+1,n} |v_n\rangle}_{|v_{n+1}\rangle} = 0$$

starting with $|v_1\rangle = \begin{bmatrix} \alpha + \beta \\ \alpha \end{bmatrix}$

- The partition function of M_n can be obtained from v_n :

$$Z_n(\alpha, \beta) = \langle \mathbf{1}_n | v_n \rangle = 2^{\binom{n-1}{2}} (1 + 2\alpha)^{n-1} (1 + \beta)^{n-1} (2\alpha + \beta)$$

transfer matrices by induction

$$\left(\begin{array}{c|c} \begin{array}{l} T_1 M_{L-1} + T_2 M_{L-1}/\alpha \\ -\alpha T_1(\sigma \otimes \mathbf{1}) + 2\alpha T_2 \end{array} & \begin{array}{l} \alpha T_1 + 2T_2 M_{L-1} - 2T_2 + T_1(\sigma \otimes \mathbf{1}) \\ -2\alpha T_2(\sigma \otimes \mathbf{1}) + T_2(\sigma \otimes \mathbf{1})M_{L-1}/\alpha \end{array} \\ \hline \begin{array}{l} T_2 M_{L-1} + T_2 \\ -\alpha T_2(\sigma \otimes \mathbf{1}) \end{array} & \begin{array}{l} \alpha T_2 - T_2/\alpha \\ +T_2 M_{L-1}/\alpha \end{array} \\ \hline \begin{array}{l} 2T_2 M_{L-1} - \alpha T_2(\sigma \otimes \mathbf{1}) \\ \alpha T_2 \end{array} & \begin{array}{l} \alpha T_2 + T_2(\sigma \otimes \mathbf{1}) + T_2(\sigma \otimes \mathbf{1})M_{L-1} \\ T_2 M_{L-1} - T_2 - \alpha T_2(\sigma \otimes \mathbf{1}) \end{array} \end{array} \right),$$

$$\left(\begin{array}{c|c} \begin{array}{l} M_{L-1} T_1 + M_{L-1} T_2/\alpha \\ -\alpha(\sigma \otimes \mathbf{1}) T_1 + 2\alpha T_2 \end{array} & \begin{array}{l} T_2 + 2M_{L-1} T_2 - \alpha(\sigma \otimes \mathbf{1}) T_2 \\ +(\sigma \otimes \mathbf{1}) T_2/\alpha + M_{L-1} T_2(\sigma \otimes \mathbf{1})/\alpha \\ -(\sigma \otimes \mathbf{1}) T_2(\sigma \otimes \mathbf{1}) \end{array} \\ \hline \begin{array}{l} M_{L-1} T_2 + T_2 \\ -\alpha(\sigma \otimes \mathbf{1}) T_2 \end{array} & \begin{array}{l} \alpha T_2 + M_{L-1} T_2/\alpha \\ -T_2/\alpha - (\sigma \otimes \mathbf{1}) T_2 + T_2(\sigma \otimes \mathbf{1}) \end{array} \\ \hline \begin{array}{l} \alpha T_1 + 2M_{L-1} T_2 - T_2 \\ -2\alpha(\sigma \otimes \mathbf{1}) T_2 \\ \alpha T_2 \end{array} & \begin{array}{l} 2\alpha T_2 + M_{L-1} T_2(\sigma \otimes \mathbf{1}) \\ +(\sigma \otimes \mathbf{1}) T_2 - \alpha(\sigma \otimes \mathbf{1}) T_2(\sigma \otimes \mathbf{1}) \\ M_{L-1} T_2 - T_2 - \alpha(\sigma \otimes \mathbf{1}) T_2 \end{array} \end{array} \right)$$

the eigenvalue conjecture for $M_n(\alpha, \beta)$ (Ayyer, Mallick)

- The characteristic polynomial of M_n is given by

$$A_n(z) A_n(z + 2\alpha + \beta) B_n(z + \beta) B_n(z + 2\alpha)$$

where

$$A_n(z) = \prod_{k \geq 0} (z + 2k)^{\binom{n-1}{2k}} \quad B_n(z) = \prod_{k \geq 0} (z + 2k + 1)^{\binom{n-1}{2k+1}}$$

- This was proved by myself, the proof works in a more general setting
- Main ingredient: the M_n are Hadamard-conjugate to triangular matrices

$$H_n \cdot M_n \cdot H_n \simeq \widetilde{M}_n$$

where

$$H_n = \frac{1}{2^{n/2}} \begin{bmatrix} 1 & 1 \\ 1 & -1 \end{bmatrix}^{\otimes n}$$

generalized matrix of transition rates for $n = 3$

$$M_3(\alpha, \beta, \gamma, \delta) = \begin{bmatrix} * & \delta & & \gamma & \alpha & & \beta \\ & * & \gamma & & & \alpha & \beta \\ & & * & \delta & \beta & & \alpha \\ & & & * & & \beta & \alpha \\ \alpha & & & & * & \delta & \gamma \\ & \alpha & & & & * & \gamma \\ & & \alpha & & & & * & \delta \\ & & & \alpha & & & & * \end{bmatrix}$$

$\alpha : 0xy \rightarrow 1xy, 1xy \rightarrow 0xy$

$\beta : 11y \rightarrow 00y, 10y \rightarrow 01y$

$\gamma : x11 \rightarrow x00, x10 \rightarrow x01$

$\delta : xy1 \rightarrow xy0$

$*$: column sums = 0

left creation and annihilation

right shift and annihilation

right shift and annihilation

right annihilation

about transfer matrices for the generalized process

- M_n : generator matrix for the asymmetric annihilation process with n sites and site variables x_0, x_1, \dots, x_n
- Hadamard-conjugation works here as well!
- Wanted: transfer matrices $T_{n,n-1}$ (format $2^n \times 2^{n-1}$) with

$$M_n \cdot T_{n,n-1} = T_{n,n-1} \cdot M_{n-1}$$

- The partition functions can be obtained inductively once the $T_{n,n-1}$ are known
- I have created an algebraic setting (skew tensor product) in order to describe and deduce the transfer matrices and the partition functions

deriving the partition functions inductively

- The steady state vectors (= right kernel vectors) of the M_n are given by

$$|v_1\rangle = \begin{bmatrix} x_0 + x_1 \\ x_0 \end{bmatrix} \qquad |v_k\rangle = T_{k,k-1} |v_{k-1}\rangle$$

- and the partition functions are obtained by induction

$$\begin{aligned} Z_n &= \langle 1_n | v_n \rangle \\ &= \langle 1_n | T_{n,n-1} | v_{n-1} \rangle \\ &\vdots \\ &= (2x_0 + x_n)(x_1 + x_n) \cdots (x_{n-1} + x_n) Z_{n-1} \\ &= \prod_{1 \leq j \leq n} (2x_0 + x_j) \cdot \prod_{1 \leq i < j \leq n} (x_i + x_j) \end{aligned}$$

compare the matrices

$$M_3 = \begin{bmatrix} -\alpha & \delta & & \gamma & \alpha & & \beta & & \\ & -\alpha-\delta & \gamma & & & \alpha & & & \beta \\ & & -\alpha-\gamma & \delta & \beta & & \alpha & & \\ & & & -\alpha-\gamma-\delta & & \beta & & & \alpha \\ \alpha & & & & -\alpha-\beta & \delta & & & \gamma \\ & \alpha & & & & -\alpha-\beta-\delta & \gamma & & \\ & & \alpha & & & & -\alpha-\beta-\gamma & & \delta \\ & & & \alpha & & & & -\alpha-\beta-\gamma-\delta & \\ & & & & & & & & \end{bmatrix}$$

$$\tilde{M}_3 = \begin{bmatrix} & \beta & & \gamma & & & \delta & & \\ -2\alpha-\beta & & \gamma & & & & & & \delta \\ & & -2\alpha-\gamma & \beta & \delta & & & & \\ & & & -\gamma-\beta & & \delta & & & \\ & & & & -2\alpha-\delta & \beta & & \gamma & \\ & & & & & -\beta-\delta & \gamma & & \\ & & & & & & -\delta-\gamma & \beta & \\ & & & & & & & -2\alpha-\delta-\gamma-\beta & \end{bmatrix}$$

the partition functions as seen via Hadamard transform

- We know from $M_n|v_n\rangle = |0_n\rangle$ that

$$\begin{aligned} Z_n &= \prod_{1 \leq j \leq n} (2x_0 + x_j) \cdot \prod_{1 \leq i < j \leq n} (x_i + x_j) \\ &= \langle 1_n | v_n \rangle = \langle 1_n | H_n | H_n | v_n \rangle = \langle \varepsilon_n | H_n | v_n \rangle \end{aligned}$$

where $\langle \varepsilon_n | = \langle 1_n | H_n = 2^{-n/2}(1, 0, 0, \dots, 0)$

- From

$$\underbrace{H_n \cdot M_n \cdot H_n \cdot H_n}_{\sim \tilde{M}_n^t} |v_n\rangle = H_n \cdot M_n |v_n\rangle = |0_n\rangle$$

- Z_n is the first component of the left kernel of the triangular(!) matrix \tilde{M}_n (suitably normalized). Not exactly the system we studied, but close.
- In other words: we expect the partition functions Z_n to appear as

$$\text{denominators of the } Y_{2^n-1} : S_{\Delta_n}(X_{0,n}) = \prod_{0 \leq i < j \leq n} (x_i + x_j)$$

References

- detailed discussion of the physical model:
Arvind Ayyer, Kirone Mallick (C.E.A. Saclay),
Exact results for an asymmetric annihilation process with open boundaries,
J. Phys. A: Math. Gen. 343 045033 2010, 22pp.
- proof of the eigenvalue conjecture:
Arvind Ayyer, VS
The spectrum of an asymmetric annihilation process
FPSAC 2010 proceedings, DMTCS 2010, 461–472
- eigenvalues and partition function for general parameters:
VS, The fully parameterized asymmetric exclusion process with annihilation,
Séminaire Lotharingien de Combinatoire, B81a (Krattenthaler Festschrift),
35pp., 2020.
- solving (partially) the linear system for strict partitions:
VS, Trying to solve a linear system for strict partitions in 'closed form',
in: *Algorithmic Combinatorics: Enumerative Combinatorics, Special Functions and Computer Algebra*, Veronika Pillwein and Carsten Schneider
(eds.), 339–386, Springer Nature (2020).